

**MITSUBISHI
ELECTRIC**

Changes for the Better

for a greener tomorrow



INVERTER

Model

FR-F800



Enhanced Next-Generation Energy-Saving Inverter



F800

WARNING Risk of injury and electric shock
A. Read the manual and follow the safety instructions before use.
B. Handle from supply and load 10 minutes before opening this cover.
C. Do not connect earth connections.
CAUTION Risk of fire
D. Mount the inverter in a non-combustible part.
WARNING Risk of electric shock
A. Avoid the inverter for 10 minutes after the inverter has stopped.
B. Avoid the inverter for 10 minutes after the inverter has stopped.
C. Avoid the inverter for 10 minutes after the inverter has stopped.
ADVERTISMENT For a greener tomorrow
MITSUBISHI ELECTRIC

1

ENERGY SAVING

Energy Saving with Inverters

The consumed power of a variable-torque load, such as fans, pumps, and blowers, is proportional to the cube of its rotation speed. Adjusting the air volume by the inverter rotation speed control can lead to energy savings.

[Example of blower operation characteristic]

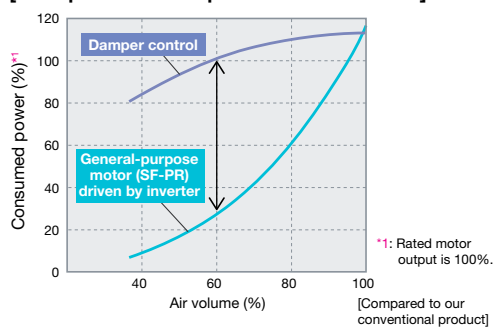

Utilizing the motor capability to the full

Optimum excitation control

- Optimum excitation control continuously adjusts the excitation current to an optimum level to provide the highest motor efficiency. With a small load torque, a substantial energy saving can be achieved. For example, at 4% motor load torque for a general-purpose motor, the motor efficiency under Optimum excitation control is about 30% higher than the motor efficiency under V/F control.

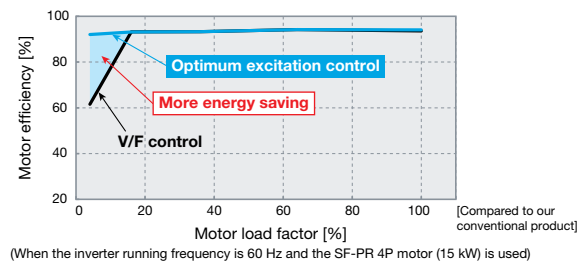

NEW Improving starting torque and saving energy at the same time

Advanced optimum excitation control

Advanced optimum excitation control, which has been newly developed, provides a large starting torque while maintaining the motor efficiency under the conventional Optimum excitation control. Without the need of troublesome adjustment of parameters (acceleration/deceleration time, torque boost, etc.), acceleration is done in a short time. Also, energy saving operation with the utmost improved motor efficiency is performed during constant-speed operation.

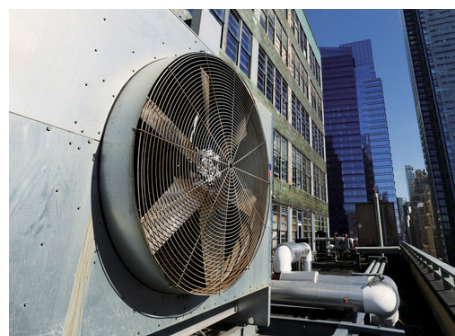

NEW Supporting operations of various motors

Offline auto tuning

The offline auto tuning function to measure circuit constants of the motor enables optimal operation of motors even when motor constants vary, when a motor of other manufacturers is used, or when the wiring distance is long. As well as Mitsubishi general-purpose motors, Mitsubishi PM motors (MM-EFS, MM-THE4), sensorless operation can be performed for other manufacturers' general-purpose motors*² and other manufacturers' permanent magnet (PM) motors*². The tuning function enables the Advanced optimum excitation control of other manufacturers' general-purpose motors*², which increases the use in the energy saving applications.

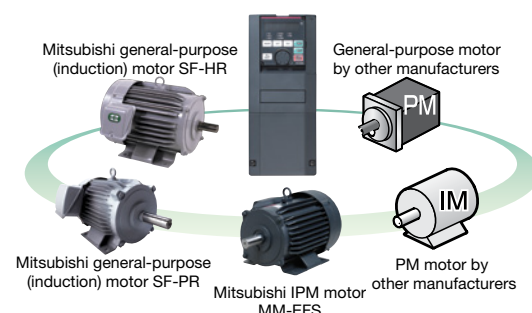

*²: Depending on the motor characteristics, tuning may not be available.

Inverter Optimum for Fan and Pump Applications

2 Energy Saving with High-Efficiency Motor

In the international context of global warming prevention, many countries in the world have started to introduce laws and regulations to mandate manufacturing and sales of high-efficiency motors. With the use of high-efficiency motors, further energy saving is achieved.

[IE code]

As an international standard of the efficiency, IEC60034-30 (energy-efficiency classes for single-speed, three-phase, cage-induction motors) was formulated in October 2008. The efficiency is classified into four classes from IE1 to IE4. The larger number means the higher efficiency.

Efficiency class IEC 60034-30	Mitsubishi motor efficiency	
	General-purpose motor	IPM motor
IE4 (super premium efficiency)*1	—	Premium high-efficiency IPM (MM-EFS/MM-THE4)
IE3 (premium efficiency)	Superline premium series (SF-PR)	—
IE2 (high efficiency)	Superline eco series (SF-HR)	—
IE1 (standard efficiency)	Superline series (SF-JR)	—
Below the class	—	—

*1: The details of IE4 are specified in IEC 60034-31.

Further energy saving with the premium high-efficiency IPM motor

MM-EFS / MM-THE4

- The IPM motor, with permanent magnets embedded in the rotor, achieves even higher efficiency as compared to the general-purpose motor (SF-PR/SF-THE3).
- The IM driving setting can be switched to IPM driving setting by only one setting. ("12" (MM-EFS/MM-THE4) in the parameter [IPM]).

Do not drive an IPM motor in the induction motor control settings.

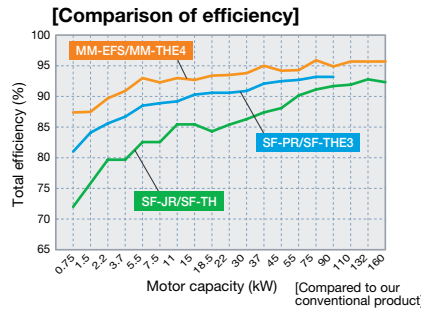

Excellent compatibility with the high-performance energy-saving motor

SF-PR

Motor constants are stored in the inverter. Energy-saving operation can be started just by setting parameters. The SF-PR motor conforms to the Japanese domestic Top Runner Standard (IE3 equivalent). Its energy-saving operation contributes reduction in the electricity charges, which in turn lowers the running cost.

Why is an IPM motor more efficient?

- No current flows to the rotor (secondary side), and no secondary copper loss is generated.
- Magnetic flux is generated with permanent magnets, and less motor current is required.
- Embedded magnets provide reluctance torque*4, and the reluctance torque can be applied.

*4: Reluctance torque occurs due to magnetic imbalance on the rotor.

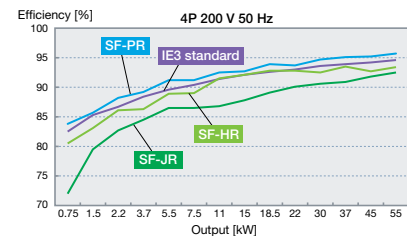
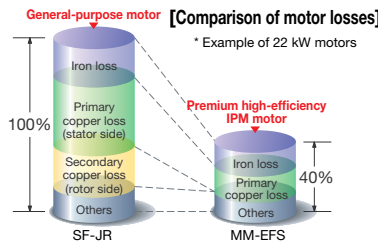

3 Energy-Saving Functions Suitable for Various Systems

Standby power reduction



- With the 24 VDC external power supply, the input MC signal can be turned OFF after the motor is stopped, and turned ON before activating the motor. The inverter enables self power management to reduce standby power.
- The inverter cooling fan can be controlled depending on the temperature of the inverter heatsink. Also, signals can be output in accordance with the inverter cooling fan operation. When the fan is installed on the enclosure, the enclosure fan can be synchronized with the inverter cooling fan. Extra power consumption when the motor is stopped can be reduced.

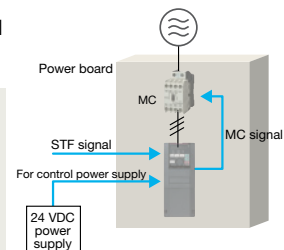
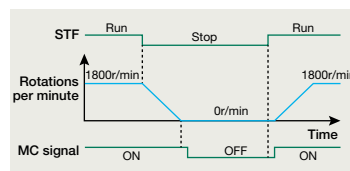

Energy saving at a glance

Energy saving monitor / Pulse train output of output power

- Energy saving monitor is available. The energy saving effect can be checked using an operation panel, output terminal, or network.
- The output power amount measured by the inverter can be output in pulses. The cumulative power amount can be easily checked.

(This function cannot be used as a meter to certify electricity billings.)



With the Mitsubishi energy measuring module, the energy saving effect can be displayed, measured, and collected.

Effective use of the regenerative energy Option

FR-CV / FR-HC2

Multiple inverters can be connected to the power regeneration common converter (FR-CV) or the high power factor converter (FR-HC2) through a common PN bus. The regenerated energy is used by another inverter, and if there is still an excess, it is returned to the power supply, saving on the energy consumption. The 355K or higher models are inverter-converter separated types, which are suitable for power regeneration.

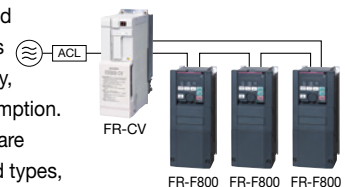

2

FUNCTIONS IDEAL FOR FANS AND PUMPS



1 Optimum Inverter Capacity Selection

Multiple rating

The rating can be selected between the two types (LD (light duty) or SLD (superlight duty)) depending on the load of the fan/pump to be used. The optimum inverter capacity can be selected suitable for the motor to be used.

For the 200 V class 90K or higher and the 400 V class 75K or higher, a motor with one-rank higher capacity can be combined.

Load	Rating	Overload current rating
Superlight duty	SLD rating	110% 60 s, 120% 3 s (inverse-time characteristics) at surrounding air temperature 40°C
Light duty	LD rating	120% 60 s, 150% 3 s (inverse-time characteristics) at surrounding air temperature 50°C

For the list of inverters by rating, refer to page 11.

2 Further Enhanced PID Control



System cost reduction PID multiple loops (two loops)

Two PID operation units are available in the inverter. The inverter can perform PID control of the motor operation and control the external equipment at the same time. The system cost can be reduced because no external PID controller is required for controlling the external equipment.

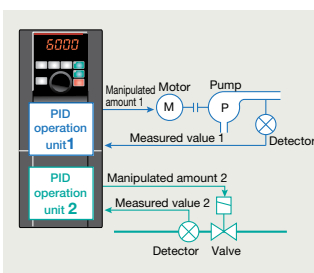

Direct setting of the PID set point

The PID set point can be set directly from the operation panel. The setting can be easily changed at hand.



Visibility improvement

With the LCD operation panel (FR-LU08), the unit can be changed from "%" to other easy-to-see units. Maintenance and adjustment is facilitated by using a familiar unit of air volume, temperature, etc. for indication.

LCD operation panel (FR-LU08) (Option)



Avoidance of rapid acceleration/deceleration using PID action

PID pre-charge function

Before PID action, the water flow to the pipe is controlled by operating the motor at a constant speed until the measured value (pressure, etc.) reaches the set level. This function is used to avoid rapid acceleration/deceleration caused by starting the PID action while the pipe is empty, and prevent a water hammer action, etc.

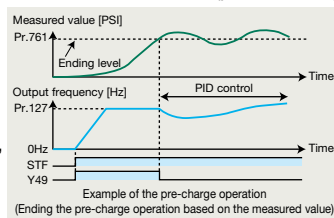

Water volume control with multiple pumps

Multi-pump function

By controlling the pumps connected in parallel (up to four pumps) by the PID control by one inverter, water volume, etc. can be adjusted.

One of the connected pumps is driven by the inverter. Other pumps are driven by commercial power supply. The number of pumps to be driven by commercial power supply is automatically adjusted according to the water volume.

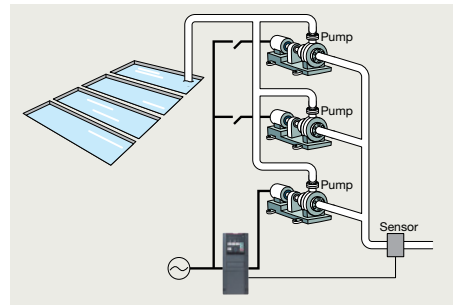

Energy saving in low-speed operation

PID output shutoff (sleep) function

During PID control, the operation is stopped when the deviation (set point - measured value) is small and the output frequency is low, and the operation is restarted when the deviation becomes large. This function restricts energy consumption during low-speed operation with low motor efficiency.

Shorter start-up time under PID control

PID automatic switchover function

The operation is started without PID control until the output frequency reaches the specified frequency. PID control is automatically started when the output frequency reaches the specified frequency. The system can be started faster at the start of operation.

3 Operating Status Monitoring

NEW Detection of mechanical faults

Load characteristics measurement function

The speed/torque relationship is stored while no fault occurs. By comparing the present load status with the stored load characteristics, out-of-range warnings can be output if applicable. Mechanical faults such as clogging of the filter or breakage of the belt can be easily detected, and maintenance is facilitated.

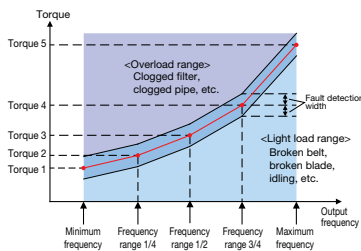

NEW Cleaning of fans and pumps

Cleaning function

Foreign matter on the impellers or fans of pumps can be removed by repeating forward/reverse rotation and stopping of the motor. (Use this function when a back flush does not pose a problem.) This function can be also automatically started when the result of load characteristics measurement is out of range (overload).

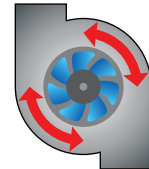

4 Smooth Restart

Automatic restart after instantaneous power failure / flying start function

After an instantaneous power failure, the operation is restartable from the coasting motor speed. With the advanced flying start function, the operation can be smoothly started from low speed.

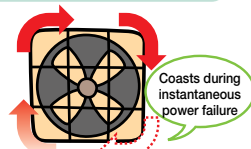

5 Keep Running during Flying Start Operation

Regeneration avoidance function

The operation frequency is automatically increased to prevent the regenerative overvoltage fault from occurring. This function is useful when a load is forcibly rotated by another fan in the duct.

6 PLC Control with an Inverter

NEW PLC function in the inverter

- Parameters and setting frequency can be changed at the program. Control programs can be created in sequence ladders using the inverter setup software (FR Configurator2).
- Inverter control such as inverter operations triggered by input signals, signal output based on inverter operation status, and monitor output can be freely customized based on the machine specifications.
- All machines can be controlled by the inverter alone, and control can also be dispersed.
- Time-based operation is possible by using in combination with the real-time clock function (when using a LCD operation panel (FR-LU08)).

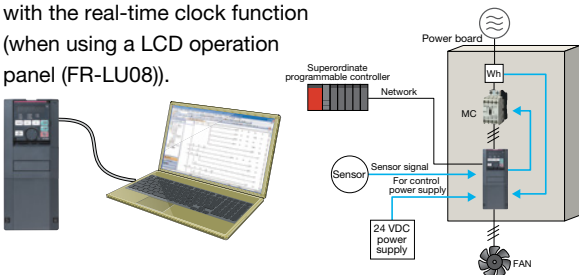

7 Compatibility with Various Systems

Compatibility with various networks

It supports BACnet® MS/TP as standard, as well as Mitsubishi inverter protocol and Modbus-RTU (binary) protocol. Communication options are also available for the major network protocols such as CC-Link, CC-Link IE Field, LONWORKS®, FL-net remote I/O, PROFIBUS-DPV0, and DeviceNet™.

BACnet® is a registered trademark of the American Society of Heating, Refrigerating and Air-Conditioning Engineers (ASHRAE). LONWORKS® is a registered trademark of Echelon Corporation. DeviceNet™ is a trademark of the ODVA, and PROFIBUS is a trademark of the PROFIBUS User Organization.

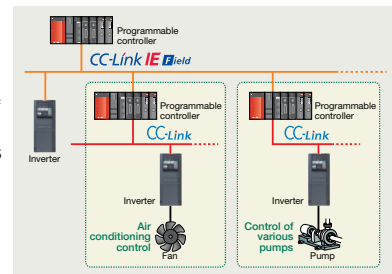

Simplified external equipment

The CA-type inverters are available. For the CA type, the monitor output terminal FM/CA operates as terminal CA (analog current output 0 to 20 mA), not as terminal FM (pulse train output). An external converter is not required.

8 Mechanical Resonance Suppression

Speed smoothing control

Vibration caused by mechanical resonance can be reduced. (Available with general-purpose motors)

9 Extended Functions

Support for up to three types of options

Three types of plug-in options can be attached. The functions of the inverter can be extended through network. For example, additional I/O terminals can be used.

3

SECURITY & SAFETY



1 Improved System Safety

NEW Safety standards compliance

Controls with safety functions can be easily performed. PLd and SIL2 are supported as standard. (STO)

- EN ISO 13849-1 PLd / Cat.3
- EN 61508, EN61800-5-2 SIL2

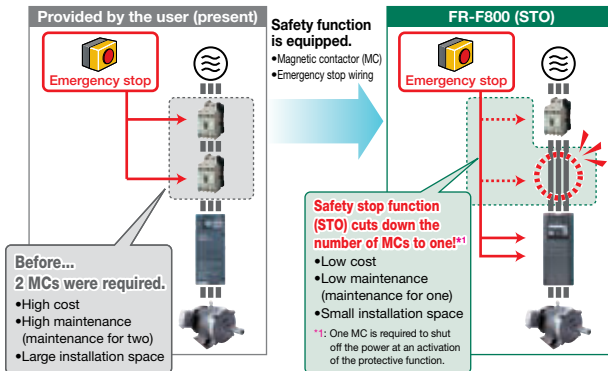

2 Reliable and Secure Maintenance

NEW Standard 24 VDC power supply for the control circuit

In addition to the existing power supply input terminals (R1 and S1) of the control circuit, 24 VDC input is equipped as standard.

The 24 VDC power supplied from outside can be fed to the control circuit locally. The parameter setting and communication operation can be done without turning ON the main power.

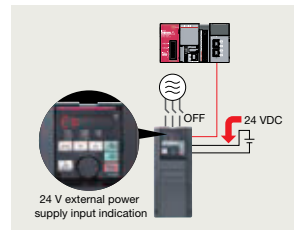

NEW Prevention of trouble with temperature monitoring

The inverter is equipped with an internal temperature sensor, which outputs a signal when the internal temperature is high. This facilitates the detection of rises in temperature inside the inverter following cooling fan malfunction, or rises in the surrounding air temperature due to inverter operating conditions.

3 Quick Reaction to Troubles

NEW Easy fault diagnosis

- The operating status (output frequency, etc.) immediately before the protection function activates can be stored in the inverter built-in RAM with the trace function. Stored data (trace data) can be copied to a USB memory device, facilitating easy trouble analysis at a separate location by reading into FR Configurator2.

Trace data stored in the built-in RAM is deleted when the power is turned OFF or the inverter is reset.

- The date and time are also saved with the trace data, making the fault analysis easier.

By using the real-time clock function with the optional LCD operation panel (FR-LU08) (when using battery), the time is not reset even when the power supply is turned OFF.

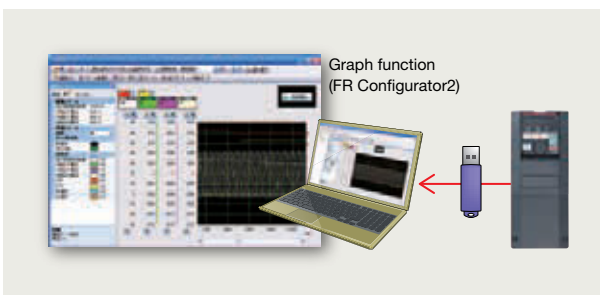
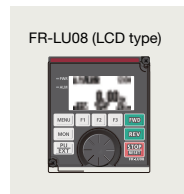

4 Protection of Critical Parameter Settings

Misoperation prevention by setting a password

- Setting a 4-digit password can restrict parameter reading/writing.



5 Long Life Components and Life Check Function

Long life components

- The service life of the cooling fans is now 10 years^{*1}.
The service life can be further extended by ON/OFF control of the cooling fan.
- Capacitors with a design life of 10 years^{**1*2} are adapted.
- Life indication of life components

Components	Estimated lifespan of the FR-F800	Guideline of JEMA ³
Cooling fan	10 years	2 to 3 years
Main circuit smoothing capacitor	10 years ^{**2}	5 years
Printed board smoothing capacitor	10 years ^{**2}	5 years

^{*1} Surrounding air temperature: Annual average of 40°C (free from corrosive gas, flammable gas, oil mist, dust and dirt).

The design life is a calculated value and is not a guaranteed product life.

^{**2} Output current: 80% of the inverter rating

^{**3} Excerpts from "Periodic check of the transistorized inverter" of JEMA (Japan Electrical Manufacturer's Association).

NEW Enhanced life check function

- An internal thermal sensor is equipped to all inverters as standard, which enables monitoring of the installation environment. Use this function as a guide for the life diagnosis.
- Maintenance timers are available for up to three peripheral devices, such as a motor and bearings.

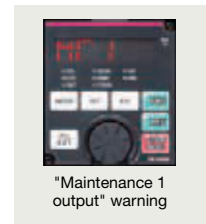

"Maintenance 1 output" warning

6 Renewal Assurance

Compatibility with existing models

- The inverter installation method is the same as that for the FR-F700(P) series, eliminating any concerns over replacement (except for some capacity models).

Furthermore, the FR-F700(P) series control circuit terminal blocks can be installed with the use of an option (FR-A8TAT).



- **NEW** The terminal response adjustment function allows a user to adjust the response speed in accordance with the existing facility. (The response time is shorter for the FR-F800 series.)
- In addition to the FR-F700(P) series' parameter settings, the FR-F500 series parameter settings (to be supported soon) can be easily copied to the FR-F800 series by using the conversion function of FR Configurator2.

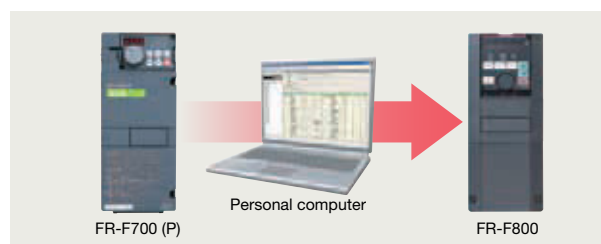

4

COMPATIBILITY WITH THE ENVIRONMENT



1 Suppression of Outgoing Harmonic Current and EMI

•By attaching the EMC filter connector to the ON or OFF position, the built-in EMC filter can be set enabled/disabled*1*2. When it is enabled, the inverter conforms to the EMC Directive (EN61800-3/1st Environment Category C1/C2*3) by itself.

*1: Enabling the EMC filter increases leakage current.

*2: The input side common mode choke, which is built in the 55K or lower inverter, is always enabled regardless of the EMC filter ON/OFF connector setting.

*3: Refer to the EMC Installation Guidelines for the required specifications.

•With a high power factor converter (FR-HC2), the inverter is equivalent to a self-excitation three-phase bridge circuit in the "Harmonic Suppression Guidelines for Specific Consumers" in Japan, and realizes the equivalent capacity conversion coefficient $K5=0$. For the 355K or higher, the converter is separated. Therefore, installation space can be saved when connecting the FR-HC2.



2 Protected in Hazardous Environments

Special-purpose inverters with circuit board coating (IEC60721-3-3 3C2/3S2) and plated conductors are available for improved environmental resistance.

For the details, please contact your sales representative.

3 Global Compatibility

•The F800 series inverters are compatible with UL, cUL, EC Directives (CE marking).
•Being RoHS compliant, the FR-F800 inverters are friendly to people and the environment.

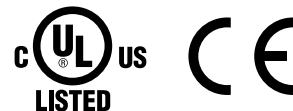

Compatible with UL, cUL, EC Directives (CE marking)

5

EASY SETUP & EASY TO USE



1 Streamlining the Startup Process

NEW Parameter copy with a USB memory device

A USB host connector (A type), which allows external device connections, has been added. Parameters can be copied to commercial USB memory devices.

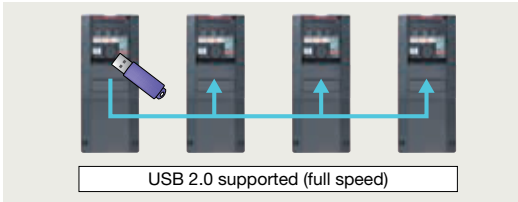

NEW Easy setup with FR Configurator2

- With the sense of unity with other Mitsubishi FA products with common MELSOFT design and operability, the software is easy to use.
- Easy plug-and-play connection is available to the USB terminal equipped as standard.

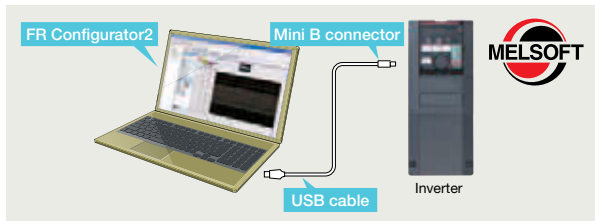

- A trial version, which contains start-up functions, is available. It can be downloaded at Mitsubishi Electric FA Global Website.

NEW Easy wiring to the control circuit

Spring clamp terminals have been adopted for control circuit terminals.

As compared to the conventional screw terminals, spring clamp terminals are highly reliable and can be easily wired. Round crimping terminals can also be used by employing a control terminal option.

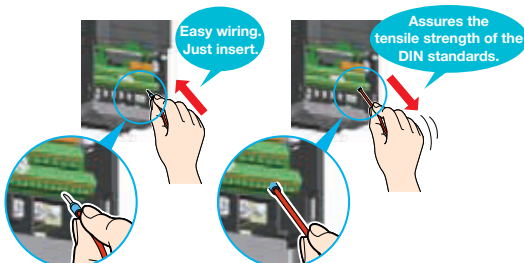

2 Easy-to-follow Display Improves the Operability

NEW Easy operation with GOT

- When the automatic connection is enabled in the GOT2000 series, the inverter can communicate with the GOT2000 series simply by connecting the GOT.
- The PLC function device monitor can be displayed at the GOT2000 series. Batch control of multiple inverter device monitors is possible with a single GOT unit.
- The sample screen data for the FR-F800 can be found in the screen design software of the GOT2000 series. The newest version of the screen design software can be downloaded from the Mitsubishi Electric FA Global Website.



NEW Easy-to-follow parameter configuration

With the parameter setting mode selection of the operation panel, the group parameter mode can be selected to provide intuitive and simple parameter settings. (The conventional parameter setting mode is selected by default.)

Major division	Name
E	Environment
F	Acceleration/deceleration
D	Start and frequency commands
H	Protective function
M	Monitor
T	Multiple function input terminals
C	Motor constant
A	Applications
N	Communication
G	Control

Conventional parameter (F700(P)) Pr. 1 2 7

New parameter (F800) Pr. A + 6 + 1 2

Group number Major division Minor division Parameter number

NEW Easy-to-read operation panel

A 5-digit, 12-segment display has been adopted for the operation panel (FR-DU08) for a more natural character display. Furthermore, another operation panel (FR-LU08) adopting an LCD panel capable of displaying text and menus is also available.

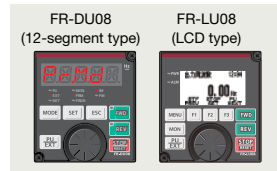

3 To Aid with Maintenance

Reduced wiring check time

Split-type covers are adapted for all capacity models. Maintenance is now easy because all an operator has to do is to remove the cover for the target wiring area.

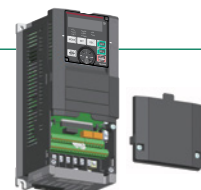

NEW Maintenance and control of multiple inverters

Serial number reading is possible using the LCD operation panel (FR-LU08) or the inverter setup software (FR Configurator2). Administration of different inverters has become much more simple.

Wide range of lineup

Inverter

Standard model

FR - F820 - 0.75K -1

Symbol	Voltage class	Symbol	Structure, functionality	Symbol ^{*1}	Description	Symbol	Type	Symbol	Circuit board coating (IEC60721-3-3 3C2/3S2 compatible)	Plated conductor
2	200 V class	0	Standard model	0.75K to 315K	LD rated inverter capacity (kW)	-1	FM	None	Without	Without
4	400 V class					-2	CA ^{*2}	-60	With	Without
								-06	With	With

Three-phase 200 V class FR-F820-[]	0.75K	1.5K	2.2K	3.7K	5.5K	7.5K	11K	15K	18.5K	22K	30K	37K	45K	55K	75K	90K	110K
	00046	00077	00105	00167	00250	00340	00490	00630	00770	00930	01250	01540	01870	02330	03160	03800	04750
●	●	●	●	●	●	●	●	●	●	●	●	●	●	●	●	●	
Three-phase 400 V class FR-F840-[]	0.75K	1.5K	2.2K	3.7K	5.5K	7.5K	11K	15K	18.5K	22K	30K	37K	45K	55K	75K	90K	110K
	00023	00038	00052	00083	00126	00170	00250	00310	00380	00470	00620	00770	00930	01160	01800	02160	02600
●	●	●	●	●	●	●	●	●	●	●	●	●	●	●	●	●	●
	132K	160K	185K	220K	250K	280K	315K										
	03250	03610	04320	04810	05470	06100	06830										
●	●	●	●	●	●	●	●										

Separated converter type

FR - F842 - 355K -1

Symbol	Voltage class	Symbol	Structure, functionality	Symbol ^{*1}	Description	Symbol	Type	Symbol	Circuit board coating (IEC60721-3-3 3C2/3S2 compatible)	Plated conductor
4	400 V class	2	Separated converter type	355K to 560K	LD rated inverter capacity (kW)	-1	FM	None	Without	Without
						-2	CA ^{*2}	-60	With	Without
								-06	With	With

Three-phase 400 V class FR-F842-[]	355K	400K	450K	500K	560K
07700	08660	09620	10940	12120	
●	●	●	●	●	

*1: Models can be alternatively indicated with the rated inverter current (SLD rating).
*2: Specification differs by the type as follows.

Type	Monitor output	Initial setting				
		Built-in EMC filter	Control logic	Rated frequency	Pr.19 Base frequency voltage	Pr.570 Multiple rating setting
FM (terminal FM equipped model)	Terminal FM (pulse train output) Terminal AM (analog voltage output (0 to ±10 VDC))	OFF	Sink logic	60Hz	9999 (same as the power supply voltage)	1 (LD rating)
CA (terminal CA equipped model)	Terminal CA (analog current output (0 to 20 mA DC)) Terminal AM (analog voltage output (0 to ±10 VDC))	ON	Source logic	50Hz	8888 (95% of the power supply voltage)	0 (SLD rating)

Converter unit

FR - CC2 - H 355K -60

Symbol	Voltage class	Symbol	Description	Symbol	Circuit board coating (IEC60721-3-3 3C2/3S2 compatible)	Plated conductor
H	400 V class	355K to 630K	Applicable motor capacity (kW)	-60	With	Without
				-06	With	With

Three-phase 400 V class FR-CC2-H[] (with the built-in DC reactor)	355K	400K	450K	500K	560K	630K
●	●	●	●	●	●	●

●: Released model

Standard Specifications

● Rating (Standard model)

◆ 200 V class

Model FR-F820-[]		00046	00077	00105	00167	00250	00340	00490	00630	00770	00930	01250	01540	01870	02330	03160	03800	04750	
		0.75K	1.5K	2.2K	3.7K	5.5K	7.5K	11K	15K	18.5K	22K	30K	37K	45K	55K	75K	90K	110K	
Applicable motor capacity (kW) *1	SLD	0.75	1.5	2.2	3.7	5.5	7.5	11	15	18.5	22	30	37	45	55	75	90/110	132	
	LD	0.75	1.5	2.2	3.7	5.5	7.5	11	15	18.5	22	30	37	45	55	75	90	110	
Output	Rated capacity (kVA) *2	SLD	1.8	2.9	4	6.4	10	13	19	24	29	35	48	59	71	89	120	145	181
		LD	1.6	2.7	3.7	5.8	8.8	12	17	22	27	32	43	53	65	81	110	132	165
	Rated current (A)	SLD	4.6	7.7	10.5	16.7	25	34	49	63	77	93	125	154	187	233	316	380	475
		LD	4.2	7	9.6	15.2	23	31	45	58	70.5	85	114	140	170	212	288	346	432
Overload current rating *3	SLD	110% 60 s, 120% 3 s (inverse-time characteristics) at surrounding air temperature 40°C																	
	LD	120% 60 s, 150% 3 s (inverse-time characteristics) at surrounding air temperature 50°C																	
Rated voltage *4		Three-phase 200 to 240 V																	
Power supply	Rated input AC voltage/frequency		Three-phase 200 to 240 V 50 Hz/60 Hz																
	Permissible AC voltage fluctuation		170 to 264 V 50 Hz/60 Hz																
	Permissible frequency fluctuation		±5%																
Protective structure (IEC 60529) *5		Enclose type (IP21)																	
Cooling system		Self-cooling			Forced air cooling														
Approx. mass (kg)		1.9	2.1	3.0	3.0	3.0	6.3	6.3	8.3	15	15	15	22	42	42	54	74	74	

*1 The applicable motor capacity indicated is the maximum capacity applicable for use of the Mitsubishi 4-pole standard motor.

*2 The rated output capacity indicated assumes that the output voltage is 220 V for 200 V class.

*3 The % value of the overload current rating indicated is the ratio of the overload current to the inverter's rated output current. For repeated duty, allow time for the inverter and motor to return to or below the temperatures under 100% load.

*4 The maximum output voltage does not exceed the power supply voltage. The maximum output voltage can be changed within the setting range. However, the maximum point of the voltage waveform at the inverter output side is the power supply voltage multiplied by about $\sqrt{2}$.

*5 FR-DU08: IP40 (except for the PU connector section)

◆ 400 V class

Model FR-F840-[]		00023	00038	00052	00083	00126	00170	00250	00310	00380	00470	00620	00770	00930	01160	01800	02160	02600	03250	03610	04320	04810	05470	06100	06830	
		0.75K	1.5K	2.2K	3.7K	5.5K	7.5K	11K	15K	18.5K	22K	30K	37K	45K	55K	75K	90K	110K	132K	160K	185K	220K	250K	280K	315K	
Applicable motor capacity (kW) *1	SLD	0.75	1.5	2.2	3.7	5.5	7.5	11	15	18.5	22	30	37	45	55	75/90	110	132	160	185	220	250	280	315	355	
	LD	0.75	1.5	2.2	3.7	5.5	7.5	11	15	18.5	22	30	37	45	55	75	90	110	132	160	185	220	250	280	315	
Output	Rated capacity (kVA) *2	SLD	1.8	2.9	4	6.3	10	13	19	24	29	36	47	59	71	88	137	165	198	248	275	329	367	417	465	521
		LD	1.6	2.7	3.7	5.8	8.8	12	18	22	27	33	43	53	65	81	110	137	165	198	248	275	329	367	417	465
	Rated current (A)	SLD	2.3	3.8	5.2	8.3	12.6	17	25	31	38	47	62	77	93	116	180	216	260	325	361	432	481	547	610	683
		LD	2.1	3.5	4.8	7.6	11.5	16	23	29	35	43	57	70	85	106	144	180	216	260	325	361	432	481	547	610
Overload current rating *3	SLD	110% 60 s, 120% 3 s (inverse-time characteristics) at surrounding air temperature 40°C																								
	LD	120% 60 s, 150% 3 s (inverse-time characteristics) at surrounding air temperature 50°C																								
Rated voltage *4		Three-phase 380 to 500 V																								
Power supply	Rated input AC voltage/frequency		Three-phase 380 to 500 V 50 Hz/60 Hz *6																							
	Permissible AC voltage fluctuation		323 to 550 V 50 Hz/60 Hz																							
	Permissible frequency fluctuation		±5%																							
Technical Data	Efficiency		Full load 100% → (97%) Load 50% → (95%) Load 20% → (90%)																							
	EMC Filter (IEC/EN 61800-3)		Category C1 (EN55011 Class B) with 50m screened motor cable up to 90KW Category C2 (EN55011 Class A1) with 150m screened motor cable up to 560KW																							
	Harmonic standard compliance		Built in (IEC/EN 61000-3-2, IEC/EN 61000-3-12)																							
	Power Factor (Rated Local)		Displacement P.F ≥ 0.98 True P.F ≥ 0.9																							
Protective structure (IEC 60529) *5		Enclose type (IP21)																								
Cooling system		Self-cooling			Forced air cooling																					
Approx. mass (kg)		2.5	2.5	2.5	3.0	3.0	6.3	6.3	8.3	8.3	15	15	23	41	41	43	52	55	71	78	117	117	166	166	166	

*1 The applicable motor capacity indicated is the maximum capacity applicable for use of the Mitsubishi 4-pole standard motor.

*2 The rated output capacity indicated assumes that the output voltage is 440 V for 400 V class.

*3 The % value of the overload current rating indicated is the ratio of the overload current to the inverter's rated output current. For repeated duty, allow time for the inverter and motor to return to or below the temperatures under 100% load.

*4 The maximum output voltage does not exceed the power supply voltage. The maximum output voltage can be changed within the setting range. However, the maximum point of the voltage waveform at the inverter output side is the power supply voltage multiplied by about $\sqrt{2}$.

*5 FR-DU08: IP40 (except for the PU connector section)

*6 For the power voltage exceeding 480 V, set **Pr.977 Input voltage mode selection**.

● Overload current rating

SLD	110% 60 s, 120% 3 s (inverse-time characteristics) at surrounding air temperature 40°C
LD	120% 60 s, 150% 3 s (inverse-time characteristics) at surrounding air temperature 50°C

● Rating (Separated converter types)

◆ 400 V class

- Inverter

Model FR-F842-[]		07700	08660	09620	10940	12120	
		355K	400K	450K	500K	560K	
Applicable motor capacity (kW) *1	SLD	400	450	500	560	630	
	LD	355	400	450	500	560	
Output	Rated capacity (kVA) *2	SLD	587	660	733	834	924
		LD	521	587	660	733	834
	Rated current (A)	SLD	770	866	962	1094	1212
		LD	683	770	866	962	1094
	Overload current rating *3	SLD	110% 60 s, 120% 3 s (inverse-time characteristics) at surrounding air temperature 40°C				
		LD	120% 60 s, 150% 3 s (inverse-time characteristics) at surrounding air temperature 50°C				
Rated voltage *4		Three-phase 380 to 500 V					
Regenerative braking torque*5 (When the converter unit (FR-CC2) is used)	Maximum brake torque	10% torque/continuous					
DC power supply voltage		430 to 780 VDC					
Control power supply auxiliary input		Single phase 380 to 500 V 50 Hz/60 Hz *7					
Permissible control power supply auxiliary input fluctuation		Frequency ±5%, voltage ±10%					
Protective structure (IEC 60529) *6		Open type (IP00)					
Cooling system		Forced air cooling					
Approx. mass (kg)		163	163	243	243	243	

*1 The applicable motor capacity indicated is the maximum capacity applicable for use of the Mitsubishi 4-pole standard motor.

*2 The rated output capacity indicated assumes that the output voltage is 440 V.

*3 The % value of the overload current rating indicated is the ratio of the overload current to the inverter's rated output current. For repeated duty, allow time for the inverter and motor to return to or below the temperatures under 100% load.

*4 The maximum output voltage does not exceed the power supply voltage. The maximum output voltage can be changed within the setting range. However, the maximum point of the voltage waveform at the inverter output side is the power supply voltage multiplied by about $\sqrt{2}$.

*5 LD rating reference value

*6 FR-DU08: IP40 (except for the PU connector section)

*7 For the power voltage exceeding 480 V, set **Pr.977 Input voltage mode selection**.

- Converter unit (FR-CC2)

Model FR-CC2-H[]		355K	400K	450K	500K	560K	630K
Applicable motor capacity (kW)		355	400	450	500	560	630
Output	Overload current rating *1	150% 60 s, 200% 3 s				120% 60 s, 150% 3 s	110% 60 s, 120% 3 s
	Rated voltage *2	430 to 780 VDC *4					
Power supply	Rated input AC voltage/frequency	Three-phase 380 to 500 V 50 Hz/60 Hz					
	Permissible AC voltage fluctuation	Three-phase 323 to 550 V 50 Hz/60 Hz					
	Permissible frequency fluctuation	±5%					
	Rated input current (A)	683	770	866	962	1094	1212
Power supply capacity (kVA) *3		521	587	660	733	833	924
Protective structure (IEC 60529)		Open type (IP00)					
Cooling system		Forced air cooling					
DC reactor		Built-in					
Approx. mass (kg)		213	282	285	288	293	294

*1 The % value of the overload current rating indicated is the ratio of the overload current to the inverter's rated output current. For repeated duty, allow time for the converter unit and the inverter to return to or below the temperatures under 100% load.

*2 The converter unit output voltage varies according to the input power supply voltage and the load. The maximum point of the voltage waveform at the converter unit output side is approximately the power supply voltage multiplied by $\sqrt{2}$.

*3 The power supply capacity is the value when at the rated output current. It varies by the impedance at the power supply side (including those of the input reactor and cables).

*4 The permissible voltage imbalance ratio is 3% or less. (Imbalance ratio = (highest voltage between lines - average voltage between three lines) / average voltage between three lines × 100)

● Common specifications

Control specifications	Control method		Soft-PWM control, high carrier frequency PWM control (selectable among V/F control (Optimum excitation control, etc.), Advanced magnetic flux vector control (Advanced optimum excitation control, etc.), and PM motor control)
	Output frequency range		0.2 to 590 Hz (The upper-limit frequency is 400 Hz under Advanced magnetic flux vector control, and PM motor control.)
	Frequency setting resolution	Analog input	0.015 Hz/60 Hz (terminal 2, 4: 0 to 10 V/12 bits) 0.03 Hz/60 Hz (0 to 5 V/11 bits or 0 to 20 mA/approx. 11 bits for terminals 2 and 4, 0 to ±10 V/12 bits for terminal 1) 0.06 Hz/60 Hz (0 to ±5 V/11 bits for terminal 1)
		Digital input	0.01 Hz
	Frequency accuracy	Analog input	Within ±0.2% of the max. output frequency (25°C ±10°C)
		Digital input	Within 0.01% of the set output frequency
	Voltage/frequency characteristics		Base frequency can be set from 0 to 590 Hz. Constant-torque/variable-torque pattern or adjustable 5 points V/F can be selected.
	Starting torque	Induction motor	120% 0.5 Hz (Advanced magnetic flux vector control)
		IPM motor	50%
	Torque boost		Manual torque boost
Acceleration/deceleration time setting		0 to 3600 s (acceleration and deceleration can be set individually), linear or S-pattern acceleration/deceleration mode, backlash countermeasures acceleration/deceleration can be selected.	
DC injection brake (induction motor)		Operation frequency (0 to 120 Hz), operation time (0 to 10 s), operation voltage (0 to 30%) variable	
Stall prevention operation level		Activation range of stall prevention operation (SLD rating: 0 to 120%, LD rating: 0 to 150%). Whether to use the stall prevention or not can be selected. (V/F control, Advanced magnetic flux vector control)	
Operation specifications	Frequency setting signal	Analog input	Terminals 2 and 4: 0 to 10 V, 0 to 5 V, 4 to 20 mA (0 to 20 mA) are available. Terminal 1: -10 to +10 V, -5 to 5 V are available.
		Digital input	Input using the setting dial of the operation panel or parameter unit Four-digit BCD or 16-bit binary (when used with option FR-A8AX)
	Start signal		Forward and reverse rotation or start signal automatic self-holding input (3-wire input) can be selected.
	Input signals (twelve terminals)		Low-speed operation command, Middle-speed operation command, High-speed operation command, Second function selection, Terminal 4 input selection, Jog operation selection, Output stop, Start self-holding selection, Forward rotation command, Reverse rotation command, Inverter reset The input signal can be changed using Pr.178 to Pr.189 (input terminal function selection) .
	Pulse train input		100 kpps
	Operational functions		Maximum frequency, minimum frequency, multi-speed operation, acceleration/deceleration pattern, thermal protection, DC injection brake, starting frequency, JOG operation, output stop (MRS), stall prevention, regeneration avoidance, increased magnetic excitation deceleration, DC feeding*1, frequency jump, rotation display, automatic restart after instantaneous power failure, electronic bypass sequence, remote setting, retry function, carrier frequency selection, fast-response current limit, forward/reverse rotation prevention, operation mode selection, slip compensation, speed smoothing control, traverse, auto tuning, applied motor selection, RS-485 communication, PID control, PID pre-charge function, cooling fan operation selection, stop selection (deceleration stop/coasting), power-failure deceleration stop function, PLC function, life diagnosis, maintenance timer, current average monitor, multiple rating, test run, 24 V power supply input for control circuit, safety stop function, self power management, BACnet communication, PID gain tuning, cleaning, load characteristics storage, emergency drive*1
	Output signal		Inverter running, Up to frequency, Instantaneous power failure/undervoltage*1, Overload warning, Output frequency detection, Fault The output signal can be changed using Pr.190 to Pr.196 (output terminal function selection) .
	Open collector output (five terminals)		Fault codes of the inverter can be output (4 bits) from the open collector.
	Relay output (two terminals)		
	Pulse train output		50 kpps
Indication	For meter	Pulse train output (FM type)	Max. 2.4 kHz: one terminal (output frequency) The monitored item can be changed using Pr.54 FM/CA terminal function selection .
		Current output (CA type)	Max. 20 mADC: one terminal (output current) The monitored item can be changed using Pr.54 FM/CA terminal function selection .
		Voltage output	Max. 10 VDC: one terminal (output voltage) The monitored item can be changed using Pr.158 AM terminal function selection .
	Operation panel (FR-DU08)	Operating status	Output frequency, output current, output voltage, frequency setting value The monitored item can be changed using Pr.52 Operation panel main monitor selection .
Fault record		Fault record is displayed when a fault occurs. Past 8 fault records and the conditions immediately before the fault (output voltage/current/frequency/cumulative energization time/year/month/date/time) are saved.	
Protective/warning function	Protective function		Overcurrent trip during acceleration, Overcurrent trip during constant speed, Overcurrent trip during deceleration or stop, Regenerative overvoltage trip during acceleration, Regenerative overvoltage trip during constant speed, Regenerative overvoltage trip during deceleration or stop, Inverter overload trip (electronic thermal relay function), Motor overload trip (electronic thermal relay function), Heatsink overheat, Instantaneous power failure*1, Undervoltage*1, Input phase loss*1+2, Stall prevention stop, Loss of synchronism detection*2, Upper limit fault detection, Lower limit fault detection, Output side earth (ground) fault overcurrent, Output phase loss, External thermal relay operation*2, PTC thermistor operation*2, Option fault, Communication option fault, Parameter storage device fault, PU disconnection, Retry count excess*2, CPU fault, Operation panel power supply short circuit/RS-485 terminals power supply short circuit, 24 VDC power fault, Abnormal output current detection*2, Inrush current limit circuit fault*1, Communication fault (inverter), Analog input fault, USB communication fault, Safety circuit fault, Overspeed occurrence*2, 4 mA input fault*2, Pre-charge fault*2, PID signal fault*2, Internal circuit fault, User definition error by the PLC function
	Warning function		Fan alarm, Stall prevention (overcurrent), Stall prevention (overvoltage), Electronic thermal relay function pre-alarm, PU stop, Parameter copy, Safety stop, Maintenance timer 1 to 3*2, USB host error, Operation panel lock*2, Password locked*2, Parameter write error, Copy operation error, 24 V external power supply operation, Load fault warning, Emergency drive*1
Environment	Surrounding air temperature		-10°C to +50°C (non-freezing) (LD ratings) -10°C to +40°C (non-freezing) (SLD rating)
	Surrounding air humidity		With circuit board coating (conforming to IEC60721-3-3 3C2/3S2): 95% RH or less (non-condensing) Without circuit board coating: 90% RH or less (non-condensing)
	Storage temperature*3		-20°C to +65°C
	Atmosphere		Indoors (without corrosive gas, flammable gas, oil mist, dust and dirt, etc.)
	Altitude/vibration		Maximum 1000 m above sea level*4, 5.9 m/s ² or less*5 at 10 to 55 Hz (directions of X, Y, Z axes)

*1 Available only for the standard model.

*2 This protective function is not available in the initial status.

*3 Temperature applicable for a short time, e.g. in transit.

*4 For the installation at an altitude above 1,000 m (up to 2,500 m), derate the rated current 3% per 500 m.

*5 2.9 m/s² or less for the FR-F840-04320(185K) or higher.

◆ CA type

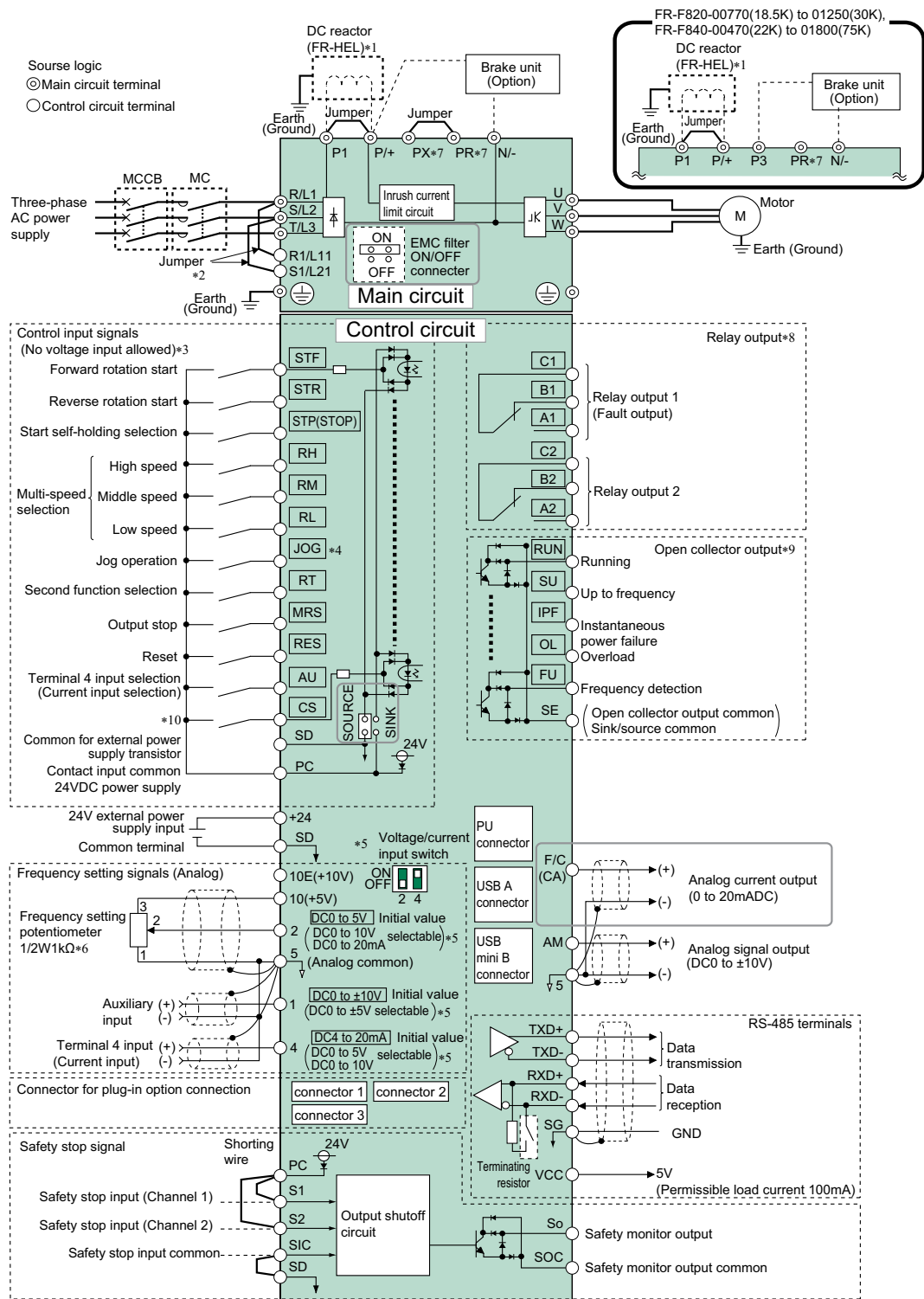

- *1 For the FR-F820-03160(75K) or higher, the FR-F840-01800(75K) or higher, always connect a DC reactor (FR-HEL), which is available as an option. (To select a DC reactor, refer to **page 18, page 106**, and select one according to the applicable motor capacity.) When a DC reactor is connected to the FR-F820-02330(55K) or lower or the FR-F840-01160(55K) or lower, if a jumper is installed across the terminals P1 and P/+, remove the jumper before installing the DC reactor.
- *2 When using separate power supply for the control circuit, remove the jumper between R1/L11 and S1/L21.
- *3 The function of these terminals can be changed with the input terminal assignment (**Pr.178 to Pr.189**).
- *4 Terminal JOG is also used as the pulse train input terminal. Use **Pr.291** to choose JOG or pulse.
- *5 Terminal input specifications can be changed by analog input specification switchover (**Pr.73, Pr.267**). To input a voltage, set the voltage/current input switch OFF. To input a current, set the voltage/current input switch ON. Terminals 10 and 2 are also used as a PTC input terminal. (**Pr.561**)
- *6 It is recommended to use 2 W 1 kΩ when the frequency setting signal is changed frequently.
- *7 Do not use terminals PR and PX. Do not remove the jumper connected to terminals PR and PX.
- *8 The function of these terminals can be changed with the output terminal assignment (**Pr.195, Pr.196**).
- *9 The function of these terminals can be changed with the output terminal assignment (**Pr.190 to Pr.194**).
- *10 No function is assigned in the initial status. Assign the function using **Pr.186 CS terminal function selection**.

● Converter unit (FR-CC2)

◆ When the sink logic is selected

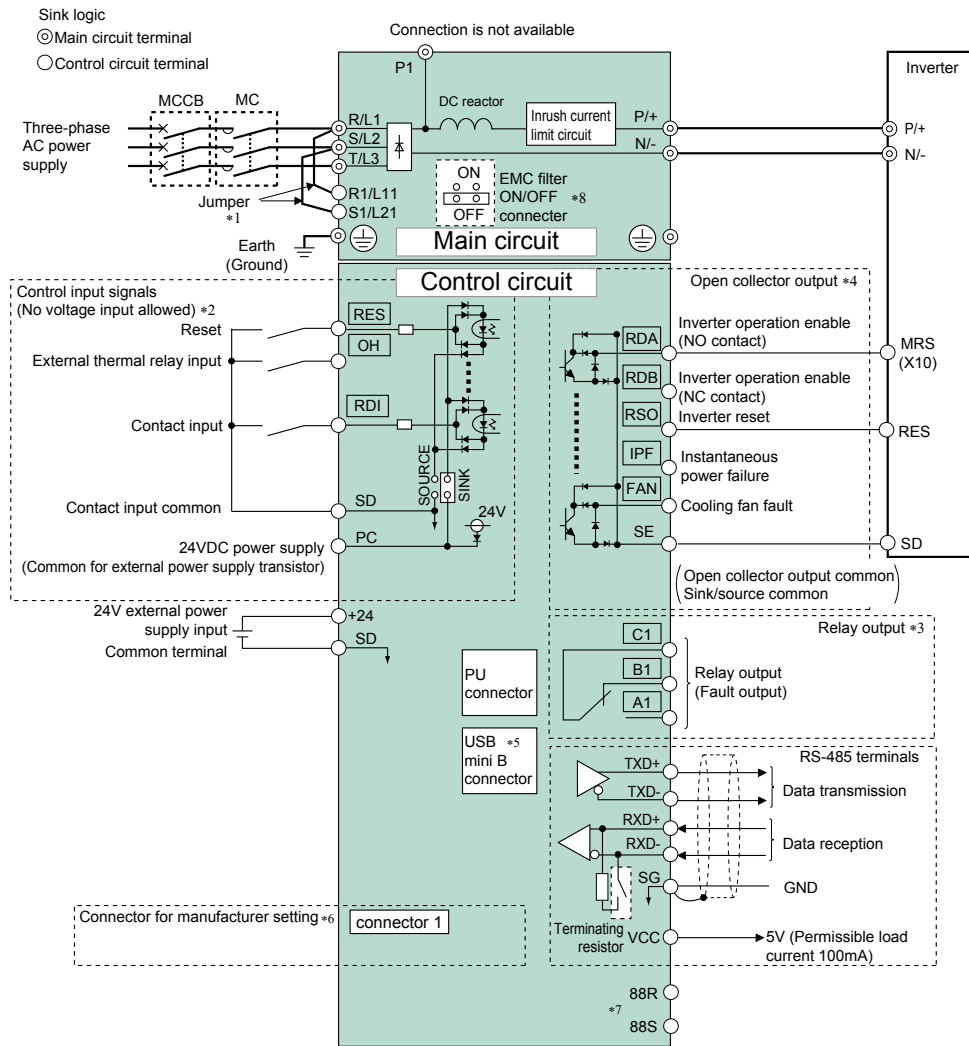

- *1 When using separate power supply for the control circuit, remove the jumpers from R1/L11 and S1/L21.
- *2 The function of these terminals can be changed with the input terminal assignment (Pr.178, Pr.187, Pr.189).
- *3 The function of these terminals can be changed with the output terminal assignment (Pr.195).
- *4 The function of these terminals can be changed with the output terminal assignment (Pr.190 to Pr.194).
- *5 The connector is for manufacturer setting. Do not use.
- *6 Plug-in options cannot be used.
- *7 For manufacturer setting. Do not use.
- *8 For the FR-CC2-H400K to H630K, two EMC filter ON/OFF connectors are provided.

Outline Dimension Drawings

Standard model

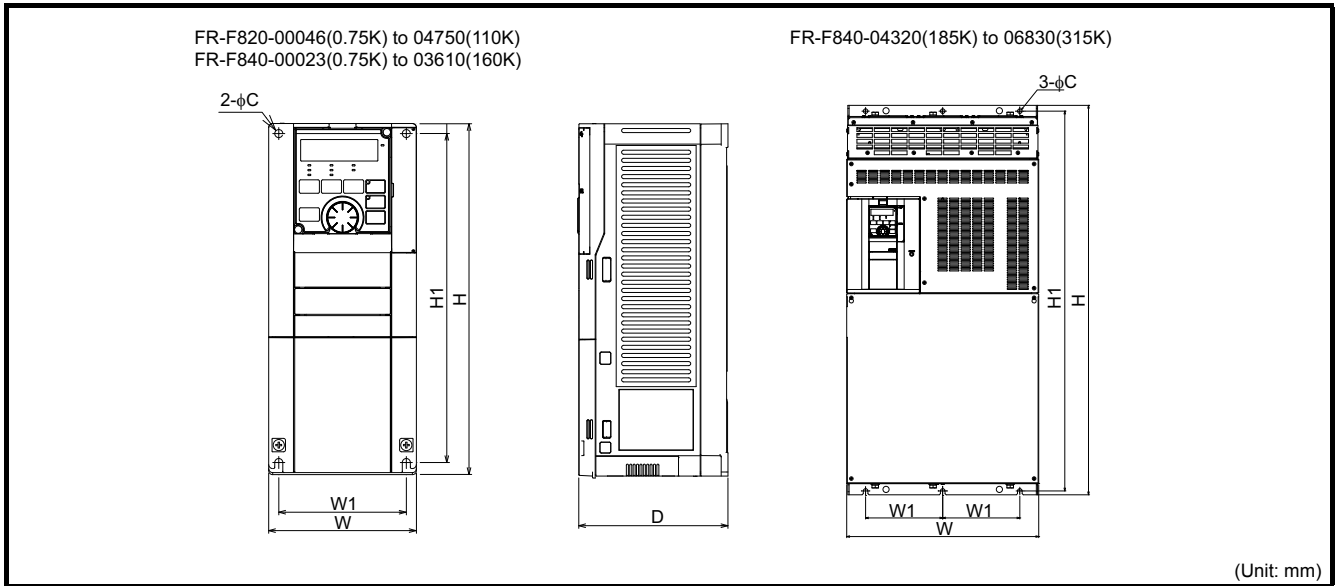

*This is a sample outline dimension drawing. The shape differs by the model.

◆ 200 V class

Inverter model	W	W1	H	H1	D	C	
FR-F820-00046(0.75K)	110	95	260	245	110	6	
FR-F820-00077(1.5K)					125		
FR-F820-00105(2.2K)	150	125	260	245	140		
FR-F820-00250(5.5K)					170		
FR-F820-00340(7.5K)	220	195	300	285	190		10
FR-F820-00490(11K)			400	380			
FR-F820-00630(15K)	250	230	400	380	190		
FR-F820-00770(18.5K)					195		
FR-F820-00930(22K)	325	270	550	530	195	12	
FR-F820-01250(30K)					250		
FR-F820-01540(37K)	435	380	550	525	250		
FR-F820-01870(45K)							700
FR-F820-02330(55K)	465	410	740	715	360		
FR-F820-03160(75K)							400
FR-F820-03800(90K)							
FR-F820-04750(110K)							

◆ 400 V class

Inverter model	W	W1	H	H1	D	C
FR-F840-00023(0.75K)	150	125	260	245	140	6
FR-F840-00038(1.5K)						
FR-F840-00052(2.2K)	150	125	260	245	140	
FR-F840-00083(3.7K)						
FR-F840-00126(5.5K)	220	195	300	285	190	
FR-F840-00170(7.5K)						
FR-F840-00250(11K)	250	230	400	380	190	10
FR-F840-00310(15K)						
FR-F840-00380(18.5K)	325	270	550	530	195	
FR-F840-00470(22K)						
FR-F840-00620(30K)	435	380	550	525	250	12
FR-F840-00770(37K)						
FR-F840-00930(45K)	465	400	620	595	300	
FR-F840-01160(55K)						
FR-F840-01800(75K)	498	200	1010	985	380	
FR-F840-02160(90K)						
FR-F840-02600(110K)	680	300	1010	984	380	
FR-F840-03250(132K)						
FR-F840-03610(160K)						
FR-F840-04320(185K)						
FR-F840-04810(220K)						
FR-F840-05470(250K)						
FR-F840-06100(280K)						
FR-F840-06830(315K)						

● Separated converter type

◆ Inverter

FR-F842-07700(355K), 08660(400K)

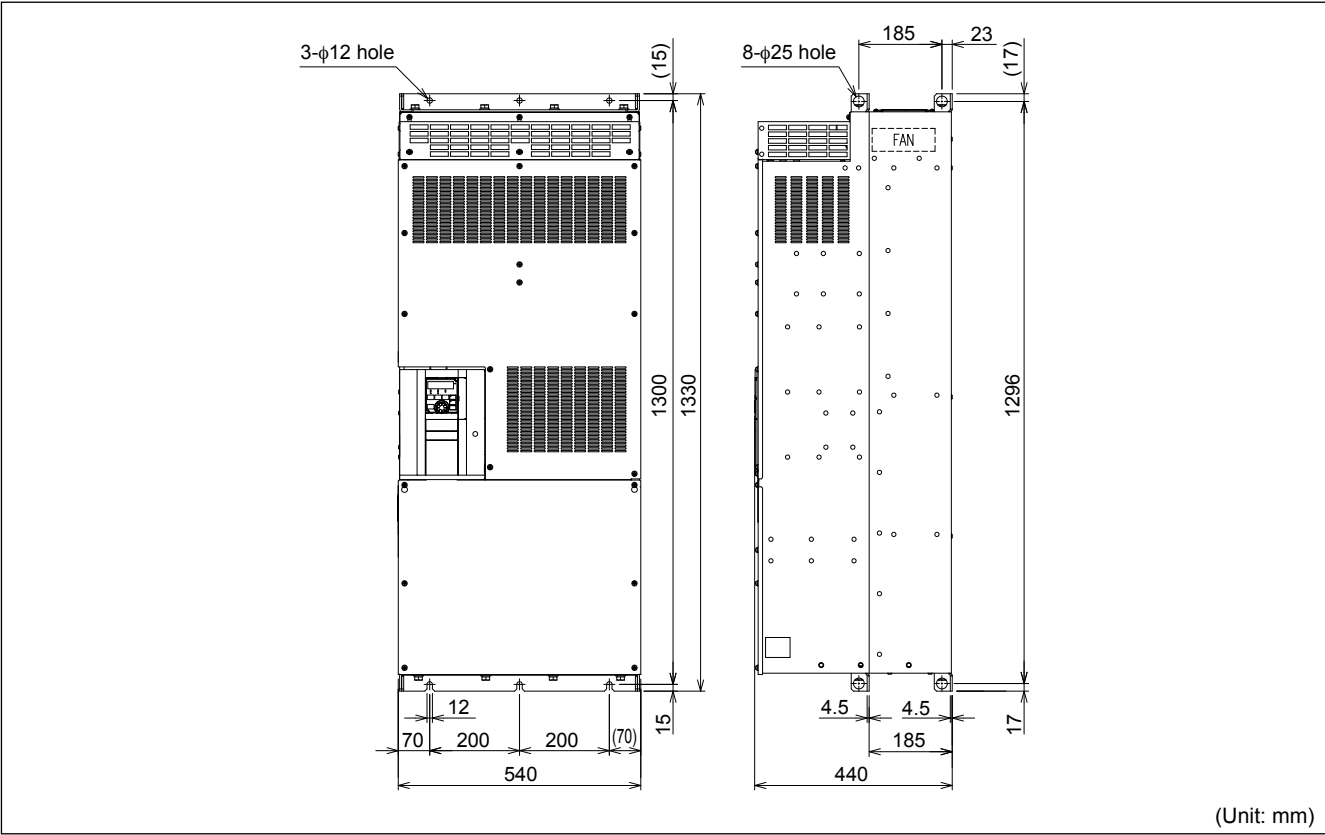

FR-F842-09620(450K), 10940(500K), 12120(560K)

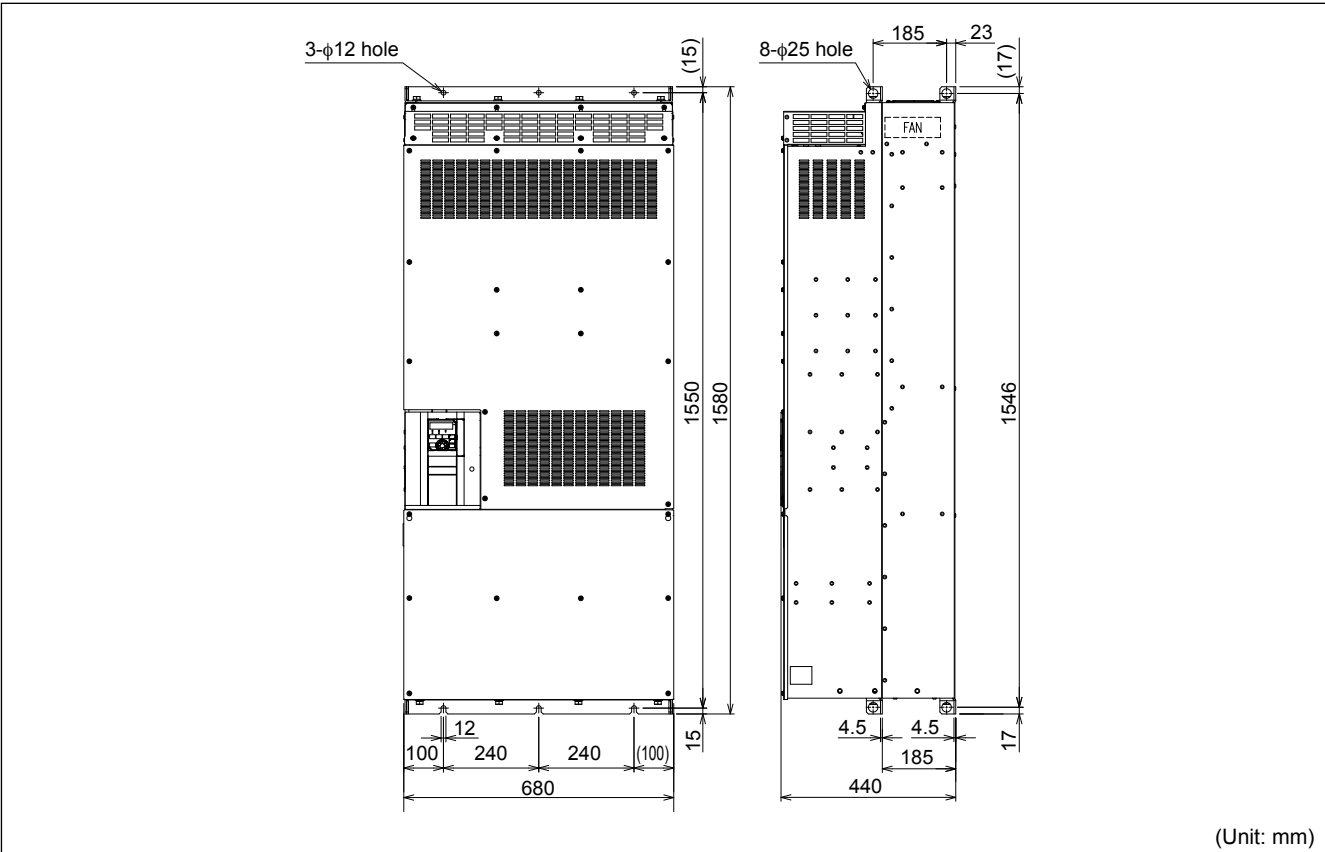

◆ Converter unit
FR-CC2-H355K

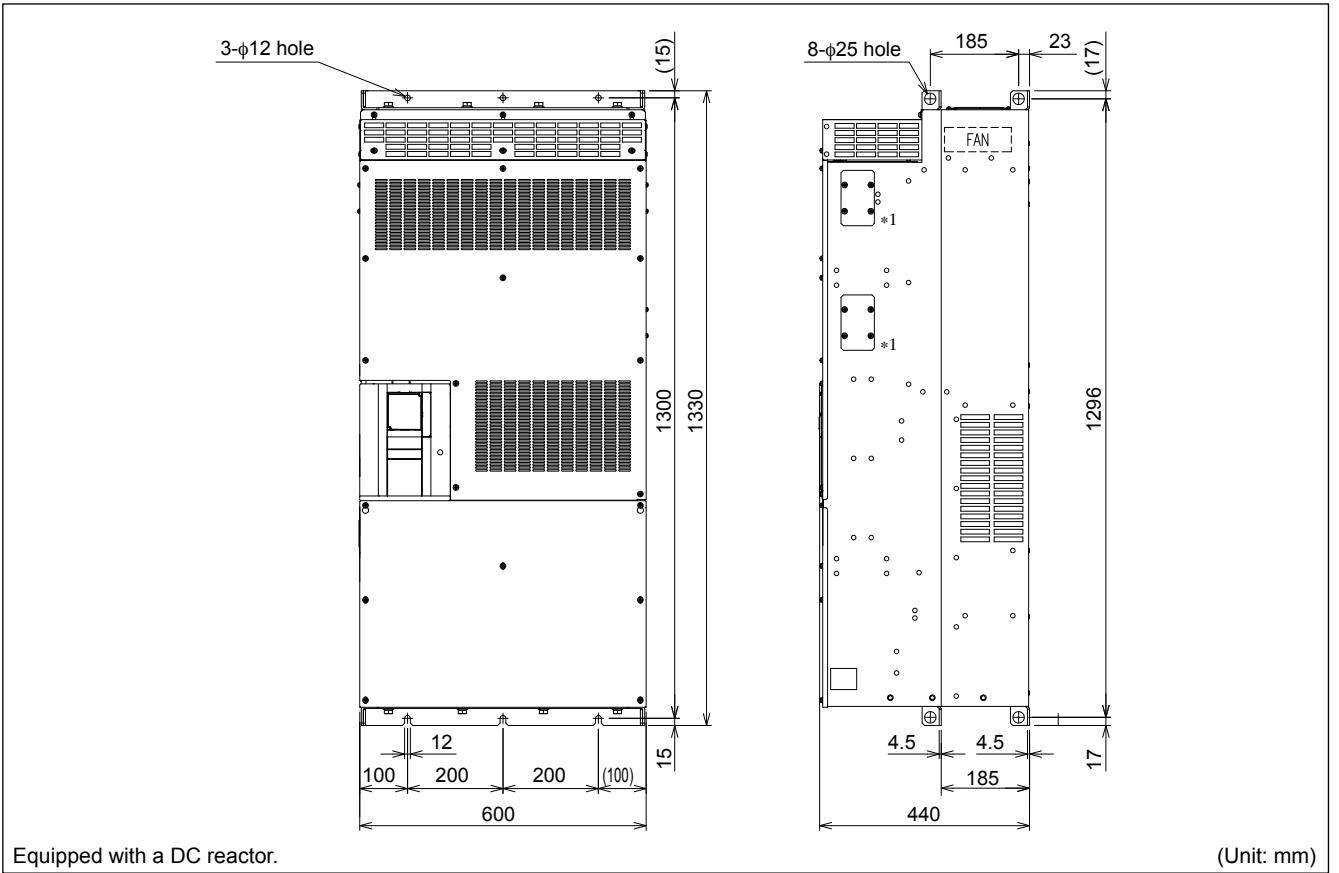

FR-CC2-H400K, H450K, H500K, H560K, H630K

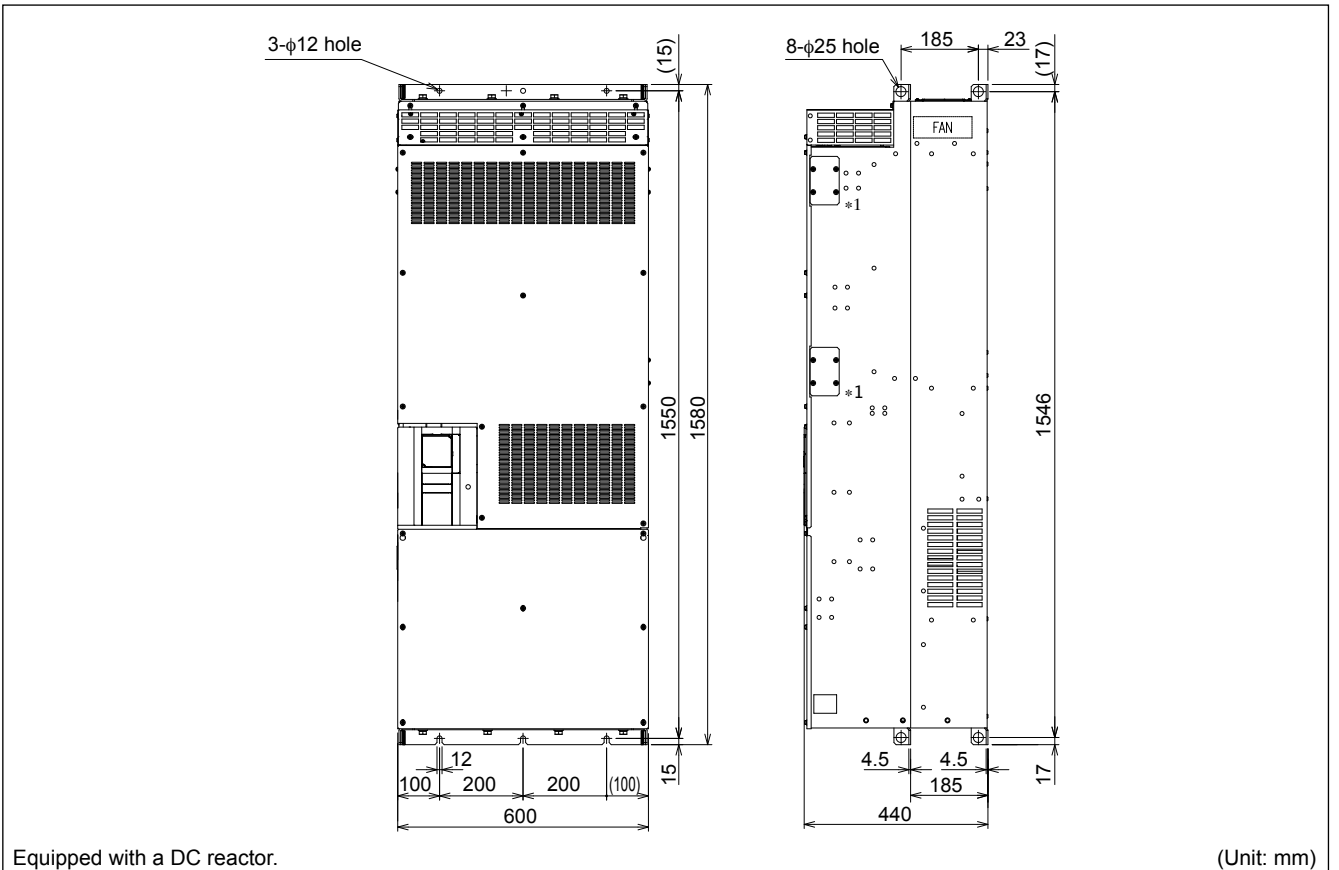

*1 Do not remove the cover on the side of the converter unit.

FR-A846 (Frequency Inverters)

EXCELLENT DRIVE PERFORMANCE

Precise, powerful, versatile



Specifications

◆ 400 V class

Type	Rated current [A]		Rated motor capacity [kW]	
	LD *1	ND *1	LD *1	ND *1
FR-A846-00023	2.1	1.5	0.75	0.4
FR-A846-00038	3.5	2.5	1.5	0.75
FR-A846-00052	4.8	4	2.2	1.5
FR-A846-00083	7.6	6	3.7	2.2
FR-A846-00126	11.5	9	5.5	3.7
FR-A846-00170	16	12	7.5	5.5
FR-A846-00250	23	17	11	7.5
FR-A846-00310	29	23	15	11
FR-A846-00380	35	31	18.5	15
FR-A846-00470	43	38	22	18.5
FR-A846-00620	57	44	30	22
FR-A846-00770	70	57	37	30
FR-A846-00930	85	71	45	37
FR-A846-01160	106	86	55	45
FR-A846-01800	144	110	75	55
FR-A846-02160	180	144	90	75
FR-A846-02600	216	180	110	90
FR-A846-03250	260	216	132	110
FR-A846-03610	325	260	160	132

*1 LD= Light duty (120 % at 60 s, 150 % at 3 s); ND= Normal duty (150 % at 60 s, 200 % at 3 s)

Operating conditions	Specifications
Power supply	3-phase, 380–500 V AC (-15 %, +10 %) at 50/60 Hz
Ambient temperature	-10 °C to +40 °C (non-freezing)
Ambient humidity	Compliance to IEC 60721-3-3 class 3C2, maximum 95 % RH (non-condensing)
Altitude	Maximum 1000 m above sea level
Protection rating	IP55
Vibration resistance	Max. 0.6 G
Break chopper	Built-in up to 55 k

Dimensions

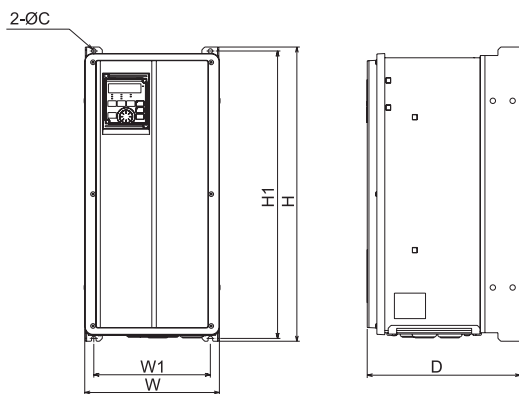

Inverter type	W	W1	H	H1	D	C
FR-A846-00023 (0.4K) to 00170 (5.5K) *1	238	201	520	508	271	8
FR-A846-00250(7.5K) to 00470(18.5K) *1			650	632.5	285	10
FR-A846-00620(22K) to 01160(45K) *1	345	300	790	770	357	12
FR-A846-01800(55K) to 02600(90K) *1	420	350	1360	1334	456.6	15
FR-A846-03250(110K) to 03610(132K) *1		290	1510	1482		

*1 From 00620 and above dimension may change

All dimensions in mm

Harmonic Mitigation Solution

INTRODUCTION - WAVE MASTER

Three Phase Harmonic Filters

Low Pass Harmonic filters reduce electrical system harmonic distortion so you can achieve maximum power system reliability and energy efficiency. They reduce all unwanted harmonic frequencies to minimal levels.

Performance from 0% to 100% load

Low Pass Harmonic filters minimize harmonics throughout the entire operating range, from 0% to 100% load, and may serve either a single load or multiple loads. They are perfect for variable torque drive applications, such as fans and pumps, plus they can be de-rated for constant torque applications requiring overload capability. Use them for either SCR or diode type rectifiers, with or without bus chokes or input line reactors.

Energy Saving!

Low Pass Harmonic Filters eliminate most of the wasted energy associated with harmonics and reduce True RMS kVA.



Solve many electrical system problems

Low Pass harmonic filters solve other power system problems such as variable frequency drive over voltage tripping, nuisance fuse blowing, circuit breaker tripping, transformer overheating, and equipment interference problems.

Using our low pass harmonic filters on your non-linear loads will extend the life of upstream electrical equipment.

Comply with international power quality standards

IEEE-519 compliance is simplified when you apply our low pass harmonic filters. Most six-pulse rectifiers will comply with IEEE-519 and other international power quality standards, when using our low pass harmonic filter.

Even better, your facility power system will be cleaner, more reliable and capacity will be freed up to handle additional loads.

Meets international power quality standards such as IEEE-519, BS G5/4, AS2279, EN61000

Time domain

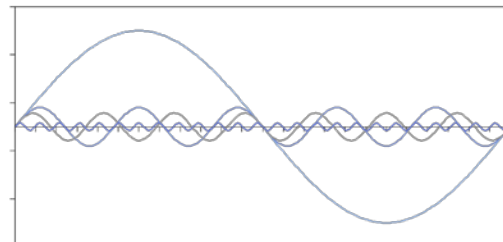

Frequency domain

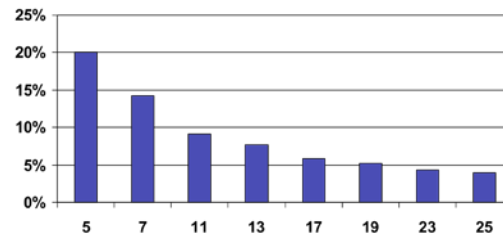

IEEE-519 THVD Limit	
Special application (hospitals, airport)	3 %
General system applications	5%
Dedicated systems (100% converter load)	10%
IEEE-519 THID Limit	
Isc/IL	TDD (Total Demand Distortion)
<20	5%
20<50	8%
50<100	12%

● Model selection

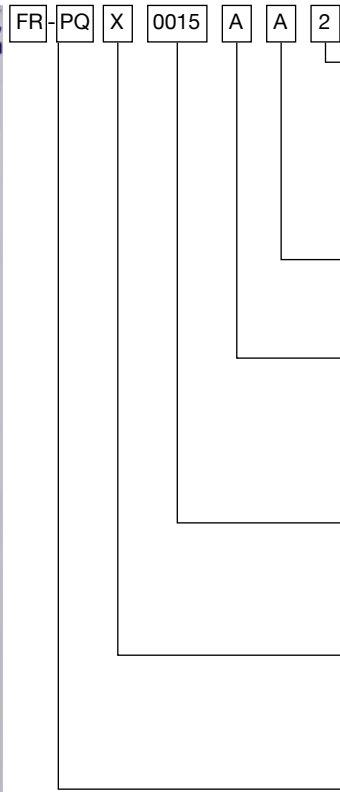
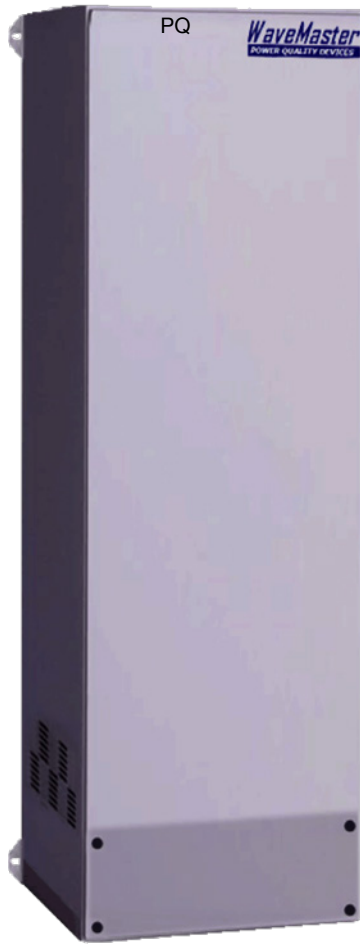

Code	Enclosure
0	Loose Parts
1	IP 00 (Open Panel)
2	IP 20
3	IP 42
4	IP 54
Code	Frequency
A	50Hz
B	60Hz
Code	Voltage Rating
A	380V – 415V
B	208V – 240V
C	440V – 480V
D	600V – 690V
Code	Current Rating
0015	15A
0026	26A
....	..A
Code	THID
A	≤5% (all loading condition)
B	≤5% (full load condition)
C	≤8% (full load condition)
Code	Series
PQ	Passive Harmonic Filter

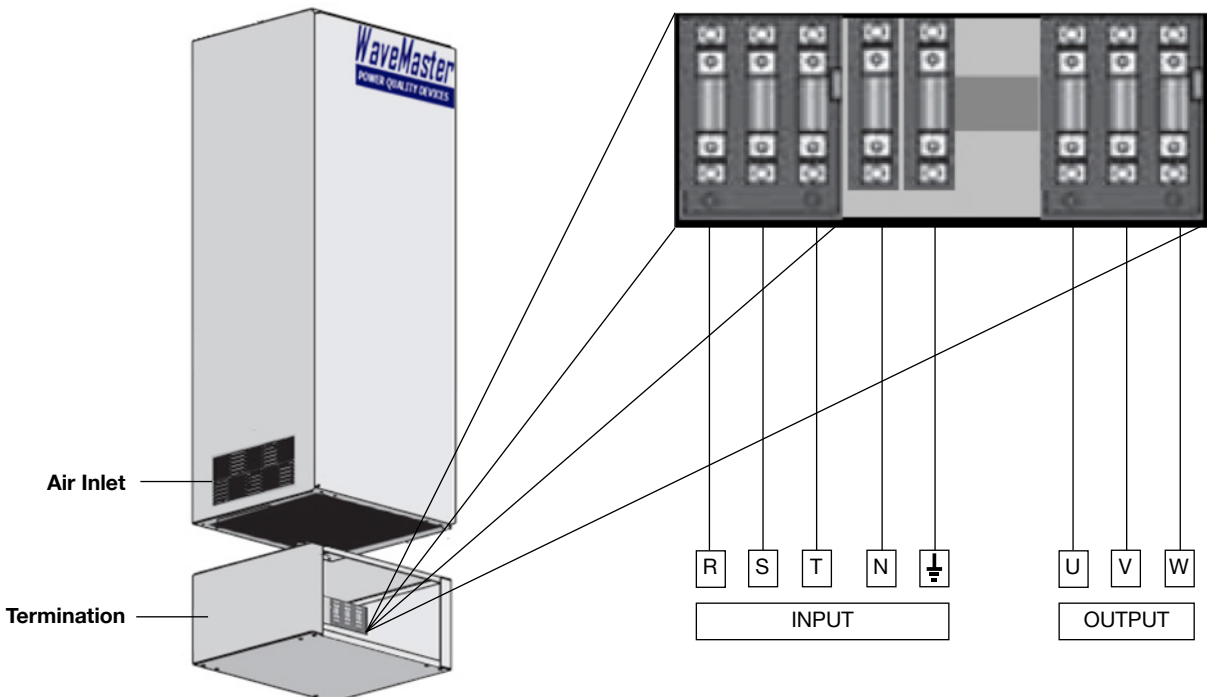

● Weight and dimension

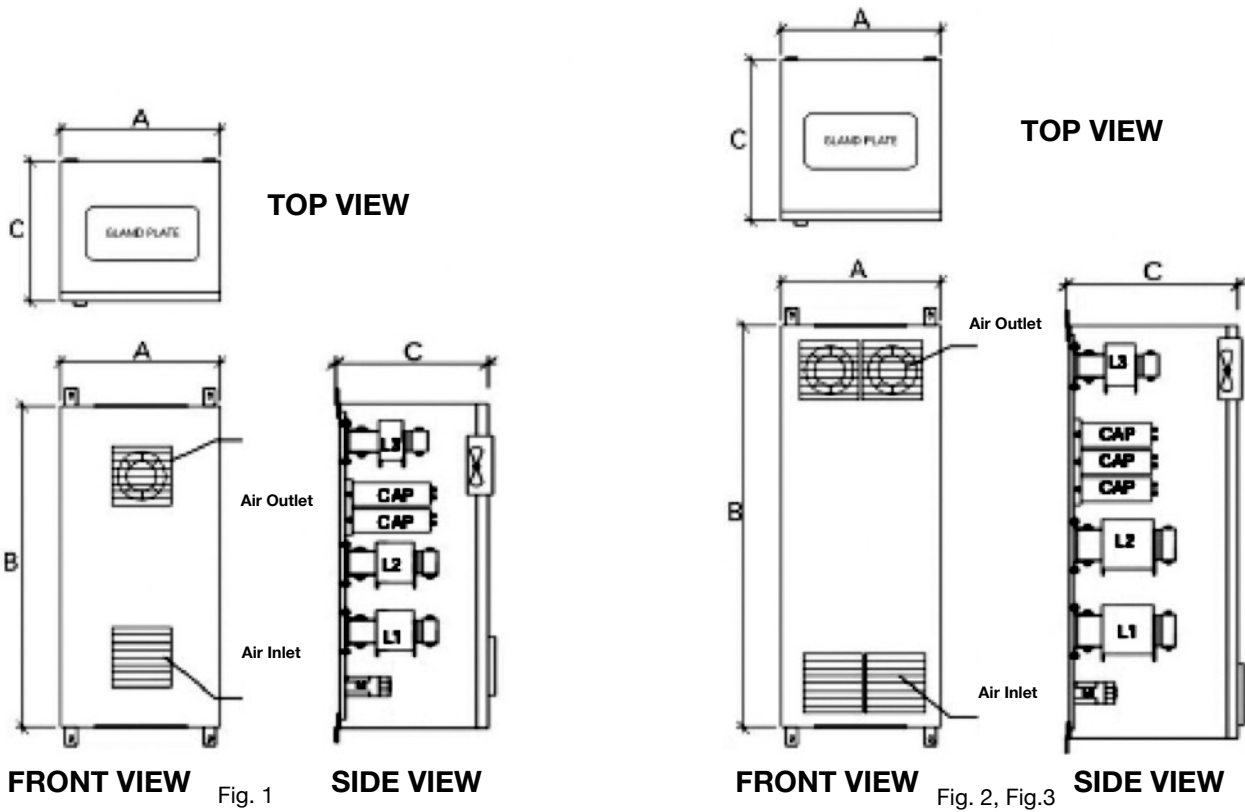

PQ Series 'C' Harmonics Filter 3 Phase/400V/50Hz						
Part Number	Current (A)	Configuration	Dimension (mm)			Weight KG
			A	B	C	
FR-PQC0008AA2	8	FIG 1	400	500	260	42
FR-PQC0015AA2	15	FIG 1	400	500	260	52
FR-PQC0026AA2	26	FIG 1	400	600	320	65
FR-PQC0035AA2	35	FIG 1	500	600	320	78
FR-PQC0046AA2	46	FIG 1	500	600	320	83
FR-PQC0059AA2	59	FIG 1	500	600	320	85
FR-PQC0078AA2	78	FIG 2	500	700	320	104
FR-PQC0098AA2	98	FIG 2	600	800	380	116
FR-PQC0117AA2	117	FIG 2	600	800	380	130
FR-PQC0137AA2	137	FIG 2	400	1000	400	145
FR-PQC0156AA2	156	FIG 2	450	1000	400	151
FR-PQC0176AA2	176	FIG 2	450	1000	400	168
FR-PQC0215AA2	215	FIG 2	450	1400	500	188
FR-PQC0234AA2	234	FIG 3	450	1400	500	192
FR-PQC0273AA2	273	FIG 3	600	2000	600	322
FR-PQC0312AA2	312	FIG 3	600	2000	600	374

Note : 1. Consult Factory for other Ratings
 2. All information printed subject to change without prior notice

● **Weight and dimension**

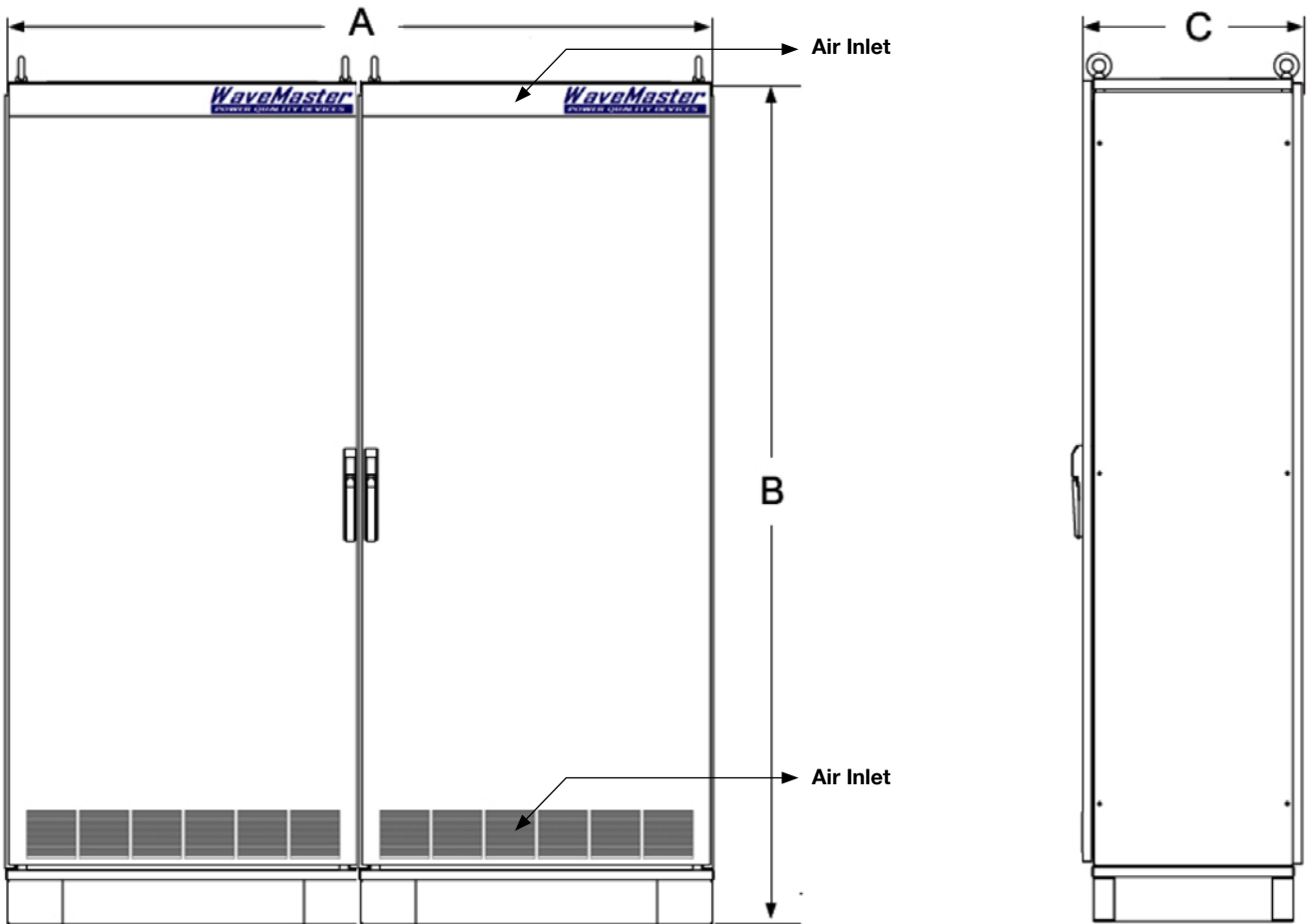

PQ Series 'C' Harmonics Filter 3 Phase/400V/50Hz						
Part Number	Current (A)	Configuration	A	B	C	KG
FR-PQC0449AA2	449	FIG 4	1200	2000	600	433
FR-PQC0527AA2	527	FIG 4	1200	2000	600	544
FR-PQC0625AA2	625	FIG 4	1200	2000	600	612
FR-PQC0781AA2	781	FIG 4	1200	2000	600	763
FR-PQC0801AA2	801	FIG 4	1200	2000	600	810
FR-PQC0918AA2	918	FIG 4	1200	2000	600	890
FR-PQC1074AA2	1074	FIG 4	1200	2000	600	930
FR-PQC1373AA2	1373	FIG 4	1200	2000	600	1050

Note : 1. Consult Factory for other Ratings
 2. All information printed subject to change without prior notice

Product specifications:

- Suitable for any source impedance and for Generators
- Suitable for 380 to 415 volts (+/- 5%)
- Suitable for system frequency of 50 Hz +/- 1 Hz
- Typical voltage regulation is +3% / -5%
- Typical input harmonic current distortion is less than 10% (Background THVD \leq 2%)

● Technical specification

System Voltage	200, 240, 380, 400, 415, 440, 480, 600, 690 Volts	
Voltage Tolerance	± 10%	
Typical Voltage Regulation	±5%	
System Frequency	50/60 Hz ± 1HZ	
Input Current Rating	8 to 3000 Amps	
Input Power Rating	4 to 2000 KW	
Voltage Line Unbalance	Up to 3% Line Voltage Unbalance (note: THiD will increase above normal levels when line voltage is unbalance)	
Source Impedance	Minimum 0.5% to 6% (Utility) Minimum 10% to Maximum 15% (Generator)	
Total Demand Distortion	Meet IEEE 519 (Table : 10.3)	
Total Harmonics Voltage Distortion	< 2% to background voltage distortion	
Total Harmonics Current Distortion	Model : PQA ≤ 5% THiD (all loading condition) Model : PQB ≤ 5% THiD (full load condition) Model : PQC ≤ 10% THiD (full loading condition)	
Ambient Temperature	-30 to + 50 degree C	
Altitude	1000 metres (Maximum)	
Relative Humidity	95%	
Maximum Power Losses	1% rated kW	
Efficiency	99% at rated load	
Dielectric Strength	Reactor (coil to coil) : 3000 volts (1 min) Capacitor: (2 x rated) + 1000 volts (1 min), min 2000 V for 1 min	
Overload Capability	1.5 x rated current (1 min, 1 times per hour)	
Damping	Self damping reactor (no power resistor require)	
Life Expectancy	> 480,000 hours at 50°C, rated kW	
ENVIRONMENTAL	Ventilation	Natural convection (No Fan required)
	Enclosures Available	Indoors, Industrial, Outdoors, Open, Kits
	Reduced KVA Demand	As much as 30% (when current distortion is reduce from 100% to 5%)
	Reduced Current Demand	As much as 30% (when current distortion is reduce from 100% to 5%)
	Potential Energy	Saving Typically by 1% to 6% (depending on transformer and conductor)
Standard	Underwriters Laboratories (UL)	Complies with UL 1531 (UL component recognized) UL File #E173113 and UL File #E112211
	IEC / EN	Complies with EN60289, EN60076-3, VDE 0532-76-6
	CE (Low Voltage Directive)	EN 60076-6, IEC 60076-6
	Harmonics Standard	Meets IEEE-519, AN-2279, EN61000-3-2, EN61000-3-12, G5/4

Service & Support



CONSULTING



SUPPORT



SHOW ROOMS



REPAIR

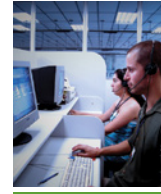

TRAINING



MITSUBISHI ELECTRIC ASIA PTE LTD.

307 Alexandra Road, Mitsubishi Electric Building Singapore 159943

TEL 65-6470-2480

FAX 65-6476-7439

URL <http://www.mitsubishielectric.com.sg>

Applicable Standards

Mitsubishi Electric's 800 Series Inverter has been designed, manufactured, and tested in accordance with the latest applicable standards as follow:

CE	Conformance to the relevant European Directives
CSA 22.2 N14-95	Industrial control equipment
EN 50178	Low Voltage Directive 2006/95/EC
EN 61800-5-1 : 2003	Low Voltage Directive 2006/95/EC
EN 60204-1	Safety of machinery-electrical equipment of machines. Part 1 – Specification for general requirement
EN60950	Safety of information technology equipment including electrical business equipment
EN 61010-1	Safety requirement for electrical equipment for measurement, control, and laboratory use, Part 1 – general requirement
EN 61800-3 : 2004	Electro Magnetic Compliance according to EMC Directive 2004/08/EC
EN 61000-3-2, EN 61000-3-12	Limits for harmonic current emissions
UL 508	Industrial control equipment
UL 508C	Power conversion equipment
IEC 664	Insulation coordination for equipment within low-voltage systems
IEC 60068-2-6	Environmental testing – Part 2 – Test Fc: vibration (sinusoidal)
IEC 60068-2-27	Environmental testing. Part 2: Tests. Test Ea and guidance: Shock
IEC 801-4	Electrical Fast Transient (Supplementary Wave)
NEMA ICS6	Industrial control and systems enclosures
NEMA 250	Enclosures for electrical equipment
SEMI F47	Specification for Semiconductor Processing Equipment voltage sag immunity

Manufacturer of the 800 Series Inverter, Nagoya Works, is a certified ISO 9001 and ISO 14000 facility



SINGAPORE GREEN BUILDING PRODUCT LABELLING SCHEME CERTIFICATE

Certificate No. G00001

Certificate Holder : **Mitsubishi Electric Asia Pte Ltd**
307 Alexandra Road,
Mitsubishi Electric Building,
Singapore 159943.

Certificate Mark : 

Product : Variable Speed Drive
Brand Name : Mitsubishi Electric
Model(s) : FR-F840-00023(0.75k) to 06830(315k)
Rating : Excellent
Standard(s) : PAG-03-VSD-0038-00
Country of Origin : Japan
Test Report(s) : BCN-A21171-046-1 & BCN-A21171-102
Issued on : 2014-12-03
Valid until : 2016-12-02

This product was assessed according to the evaluation criteria of Singapore Green Building Product Labelling Scheme.

✓ Good ✓✓ Very Good ✓✓✓ Excellent ✓✓✓✓ Leader

Page 1 of 1

Vice President (Certification)
TÜV SÜD PSB Pte Ltd

This Certificate is part of a full report and should be read in conjunction with it. This Certificate remains the property of TÜV SÜD PSB Pte Ltd and shall be returned upon request. The use of this Certificate is subjected to the Singapore Green Building Product labelling scheme Terms and Conditions. The manufacturer is solely responsible for compliance of any product that has the same designation as the product type-tested. Persons relying on this certificate should verify its validity by checking TÜV SÜD PSB's website at www.tuv-sud-psb.sg or SGBC website at www.sgbc.sg.

mitsubishi
MITSUBISHI ELECTRIC ASIA PTE LTD
307 ALEXANDRA ROAD, MITSUBISHI ELECTRIC BUILDING, SINGAPORE 159943
